



www.FGWilson.com

F17.5-1



Image for illustration purposes only.

Output Ratings

Voltage, Frequency	Prime	Standby
400V, 50 Hz	16.0 kVA / 12.8 kW	17.5 kVA / 14.0 kW
220/127V, 60 Hz	19.0 kVA / 15.2 kW	21.0 kVA / 16.8 kW

Ratings at 0.8 power factor.

Please refer to the output ratings technical data section for specific generator set outputs per voltage.

Prime Rating

These ratings are applicable for supplying continuous electrical power (at variable load) in lieu of commercially purchased power. There is no limitation to the annual hours of operation and this model can supply 10% overload power for 1 hour in 12 hours.

Standby Rating

These ratings are applicable for supplying continuous electrical power (at variable load) in the event of a utility power failure. No overload is permitted on these ratings. The alternator on this model is peak continuous rated (as defined in ISO 8528-3).

Standard Reference Conditions

Note: Standard reference conditions 25°C (77°F) Air Inlet Temp, 100m (328 ft) A.S.L. 30% relative humidity.
Fuel consumption data at full load with diesel fuel with specific gravity of 0.85 and conforming to BS2869: 1998, Class A2.

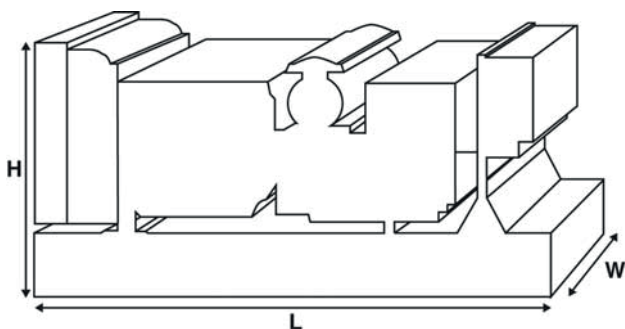

Ratings and Performance Data

Engine Make & Model:	FG Wilson FD4-1.8A1	
Alternator manufactured for FG Wilson by:	FG Wilson	
Alternator Model:	EG160-14N	
Control Panel:	DCP-10	
Base Frame:	Heavy Duty Fabricated Steel	
Circuit Breaker Type:	3 Pole MCB	
Frequency:	50 Hz	60 Hz
Engine Speed: rpm	1500	1800
Fuel Tank Capacity: litres (US gal)	75 (19.8)	
Fuel Consumption: l/hr (US gal/hr) (100% Load)	- Prime	5.1 (1.3) 6.1 (1.6)
	- Standby	5.4 (1.4) 6.4 (1.7)

Available Options

FG Wilson offer a range of optional features to tailor our generator sets to meet your power needs. Options include:

- Upgrade to CE Certification
- A wide range of Sound Attenuated Enclosures
- Additional alarms and shutdowns
- A selection of exhaust silencer noise levels

For further information on all of the standard and optional features accompanying this product please contact your local Dealer or visit: www.FGWilson.com

Dimensions and Weights

Length (L) mm (in)	Width (W) mm (in)	Height (H) mm (in)	Dry kg (lb)	Wet kg (lb)
1695 (66.7)	622 (24.5)	1050 (41.3)	441 (972)	454 (1001)
Dry = With Lube Oil		Wet = With Lube Oil and Coolant		

Ratings in accordance with ISO 8528, ISO 3046, IEC 60034, BS5000 and NEMA MG-1.22. Generator set pictured may include optional accessories.

Engine Technical Data		
No. of Cylinders / Alignment:	4 / In Line	
Cycle:	4 Stroke	
Bore / Stroke: mm (in)	85.0 (3.3)/95.0 (3.7)	
Induction:	Naturally Aspirated	
Cooling Method:	Water	
Governing Type:	Electronic	
Governing Class:	ISO 8528 G2	
Compression Ratio:	18:1	
Displacement: l (cu. in)	2.2 (131.6)	
Moment of Inertia: kg m ² (lb/in ²)	-	
Engine Electrical System:		
- Voltage / Ground	12/Negative	
- Battery Charger Amps	25	
Weight: kg (lb)	- Dry	253 (558)
	- Wet	266 (586)

Performance	50 Hz	60 Hz
Engine Speed: rpm	1500	1800
Gross Engine Power: kW (hp)		
- Prime	17.0 (23.0)	20.0 (27.0)
- Standby	17.9 (24.0)	21.0 (28.0)
BMEP: kPa (psi)		
- Prime	631.0 (91.5)	618.0 (89.7)
- Standby	664.0 (96.3)	649.0 (94.2)

Fuel System					
Fuel Filter Type:	Spin On				
Recommended Fuel:	Class A2 Diesel or BSEN590				
Fuel Consumption: l/hr (US gal/hr)					
	110%	100%	75%	50%	
Prime	Load	Load	Load	Load	
50 Hz	5.4 (1.4)	5.1 (1.3)	4.3 (1.1)	3.9 (1.0)	
60 Hz	6.4 (1.7)	6.1 (1.6)	5.5 (1.5)	5.2 (1.4)	
		100%	75%	50%	
Standby		Load	Load	Load	
50 Hz		5.4 (1.4)	4.5 (1.2)	4.0 (1.1)	
60 Hz		6.4 (1.7)	5.7 (1.5)	5.3 (1.4)	

(Based on diesel fuel with a specific gravity of 0.85 and conforming to BS2869, Class A2)

Air Systems	50 Hz	60 Hz
Air Filter Type:	Replaceable Element	
Combustion Air Flow: m ³ /min (cfm)		
- Prime	1.1 (40)	1.4 (48)
- Standby	1.1 (40)	1.4 (48)
Max. Combustion Air Intake Restriction: kPa (in H ₂ O)	5.0 (20.1)	5.0 (20.1)

Cooling System	50 Hz	60 Hz
Cooling System Capacity: l (US gal)	13.2 (3.5)	13.2 (3.5)
Water Pump Type:	Centrifugal	
Heat Rejected to Water & Lube Oil:		
kW (Btu/min)	- Prime	-
	- Standby	-
Heat Radiation to Room: Heat radiated from engine and alternator		
kW (Btu/min)	- Prime	-
	- Standby	-
Radiator Fan Load: kW (hp)	1.6 (2.2)	1.6 (2.2)
Radiator Cooling Airflow: m ³ /min (cfm)	42.6 (1505)	60.7 (2145)
External Restriction to Cooling Airflow: Pa (in H ₂ O)	125 (0.5)	125 (0.5)

Designed to operate in ambient conditions up to 50°C (122°F).
Contact your local FG Wilson Dealer for power ratings at specific site conditions.

Lubrication System	
Oil Filter Type:	Spin-On, Full Flow
Total Oil Capacity: l (US gal)	5.5 (1.5)
Oil Pan: l (US gal)	-
Oil Type:	CF4 15W-40
Oil Cooling Method:	Water

Exhaust System	50 Hz	60 Hz
Maximum Allowable Back Pressure: kPa (in Hg)	6.5 (1.9)	6.5 (1.9)
Exhaust Gas Flow: m ³ /min (cfm)		
- Prime	3.8 (135)	4.8 (170)
- Standby	3.8 (135)	4.8 (170)
Exhaust Gas Temperature: °C (°F)		
- Prime	563 (1045)	585 (1085)
- Standby	563 (1045)	585 (1085)

Alternator Physical Data	
Manufactured for FG Wilson by:	FG Wilson
Model:	EG160-14N
No. of Bearings:	1
Insulation Class:	H
Winding Pitch Code:	2/3 - -
Wires:	12
Ingress Protection Rating:	IP21
Excitation System:	SHUNT
AVR Model:	EVC300i

Alternator Operating Data	
Overspeed: rpm	-
Voltage Regulation: (Steady state)	+/-1%
Wave Form NEMA = TIF:	50
Wave Form IEC = THF:	2.0%
Total Harmonic content LL/LN:	3.0%
Radio Interference:	-
Radiant Heat: kW (Btu/min)	
- 50 Hz	2.4 (136)
- 60 Hz	2.6 (148)

Alternator Performance Data:	50 Hz			60 Hz
	415/240V	400/230V	380/220V	220/127V
Data Item				
Motor Starting Capability* kVA	27	26	23	26
Short Circuit Capacity %	-	-	-	-
Reactances: Per Unit				
Xd	1.734	1.866	2.068	2.198
X'd	0.182	0.196	0.217	0.231
X''d	0.108	0.116	0.129	0.137

Reactances shown are applicable to prime ratings.
 *Based on 30% voltage dip at 0.6 power factor and SHUNT excitation.

Output Ratings Technical Data 50 Hz				
Voltage	Prime:		Standby:	
	kVA	kW	kVA	kW
415/240V	16.0	12.8	17.5	14.0
400/230V	16.0	12.8	17.5	14.0
380/220V	16.0	12.8	17.5	14.0

Output Ratings Technical Data 60 Hz				
Voltage	Prime:		Standby:	
	kVA	kW	kVA	kW
220/127V	19.0	15.2	21.0	16.8

Documentation

A full set of operation and maintenance manuals and circuit wiring diagrams.

Generator Set Standards

The equipment meets the following standards: BS5000, ISO 8528, ISO 3046, IEC 60034, NEMA MG-1.22.

FG Wilson is a fully accredited ISO 9001 company.

Warranty

All prime equipment, limited to 2,000 running hours per year, has a one year manufacturer's warranty. Standby equipment, limited to 500 running hours per year, has a two year manufacturer's warranty. For details on warranty cover please contact your local Dealer, or visit our website: FGWilson.com.

Dealer contact details:

FG Wilson manufactures product in the following locations:

Northern Ireland • Brazil • China • India • USA

With headquarters in Northern Ireland, FG Wilson operates through a Global Dealer Network.

To contact your local Sales Office please visit the FG Wilson website at www.FGWilson.com.

FG Wilson is a trading name of Caterpillar (NI) Limited.